

# PR29MF21NSZ Series

# PR39MF2xNSZ Series

$I_T(\text{rms}) \leq 0.9\text{A}$ , Zero Cross type  
DIP 8pin  
Triac output SSR

\*Non-zero cross type is also available.  
(PR29MF1xNSZ Series/PR39MF1xNSZ Series)

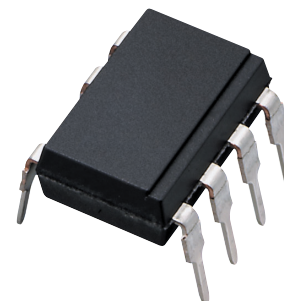

## ■ Description

**PR29MF21NSZ Series** and **PR39MF2xNSZ Series** Solid State Relays (SSR) are an integration of an infrared emitting diode (IRED), a Phototriac Detector and a main output Triac. These devices are ideally suited for controlling high voltage AC loads with solid state reliability while providing 4.0kV isolation ( $V_{\text{iso}}(\text{rms})$ ) from input to output.

## ■ Features

1. Output current,  $I_T(\text{rms}) \leq 0.9\text{A}$
2. Zero crossing functionary ( $V_{\text{OX}}$  : MAX. 35V)
3. 8 pin DIP package (SMT gullwing also available)
4. High repetitive peak off-state voltage  
( $V_{\text{DRM}}$  : 600V, **PR39MF2xNSZ Series**)  
( $V_{\text{DRM}}$  : 400V, **PR29MF21NSZ Series**)
5.  $I_{\text{FT}}$  ranks available (see Model Line-up in this datasheet)
6. Superior noise immunity ( $dV/dt$  : MIN. 100V/ $\mu\text{s}$ )
7. Response time,  $t_{\text{on}}$  : MAX. 50 $\mu\text{s}$
8. High isolation voltage between input and output  
( $V_{\text{iso}}(\text{rms})$  : 4.0kV)

## ■ Agency approvals/Compliance

1. Recognized by UL508, file No. E94758 (as model No. **R29MF2/R39MF2**)
2. Approved by CSA 22.2 No.14, file No. LR63705 (as model No. **R29MF2/R39MF2**)
3. Optionary available VDE approved <sup>(\*)</sup>(DIN EN 60747-5-2), file No. 40008898 (only for **PR39MF2xNSZ Series** as model No. **R39MF2**)
4. Package resin : UL flammability grade (94V-0)

<sup>(\*)</sup> DIN EN60747-5-2 : successor standard of DIN VDE0884.  
Up to Date code "RD" (December 2003), approval of DIN VDE0884.  
From Date code "S1" (January 2004), approval of DIN EN60747-5-2.

## ■ Applications

1. Isolated interface between high voltage AC devices and lower voltage DC control circuitry.
2. Switching motors, fans, heaters, solenoids, and valves.
3. Power control in applications such as lighting and temperature control equipment.

Notice The content of data sheet is subject to change without prior notice.

In the absence of confirmation by device specification sheets, SHARP takes no responsibility for any defects that may occur in equipment using any SHARP devices shown in catalogs, data books, etc. Contact SHARP in order to obtain the latest device specification sheets before using any SHARP device.

### Internal Connection Diagram

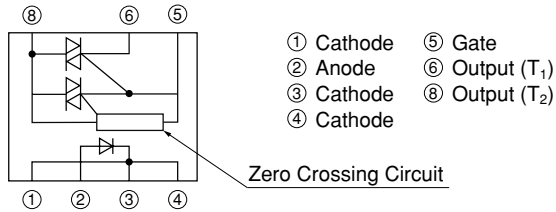

### Outline Dimensions

(Unit : mm)

#### 1. Through-Hole [ex. PR29MF21NSZF]

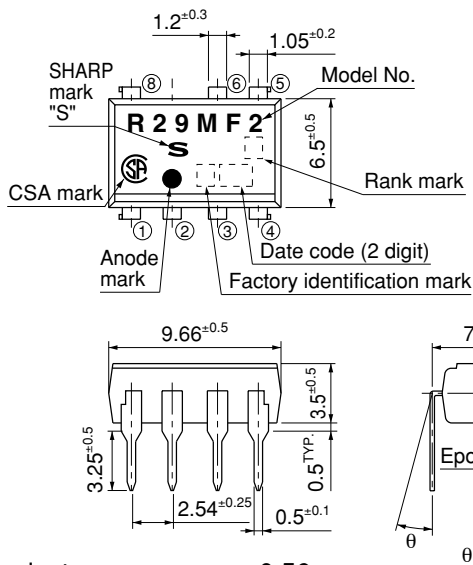

Product mass : approx. 0.56g

#### 2. SMT Gullwing Lead-Form [ex. PR29MF21NIPF]

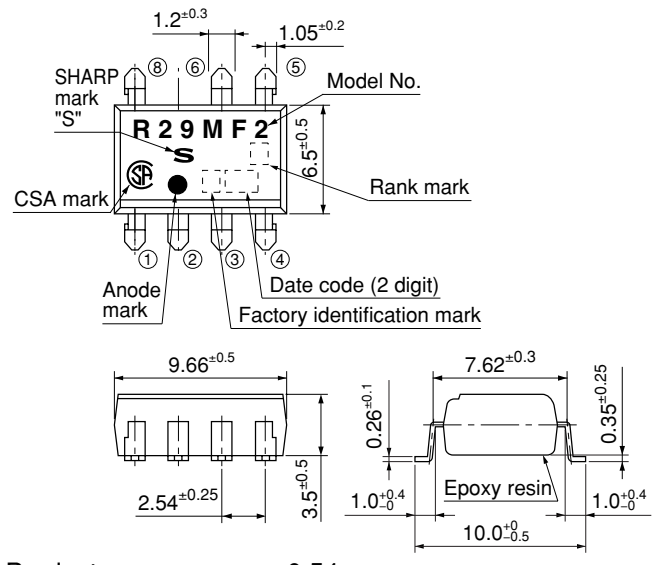

Product mass : approx. 0.54g

#### 3. Through-Hole [ex. PR39MF21NSZF]

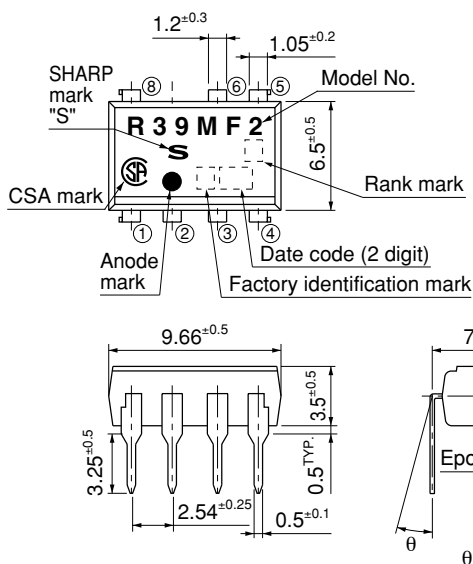

Product mass : approx. 0.56g

#### 4. SMT Gullwing Lead-Form [ex. PR39MF21NIPF]

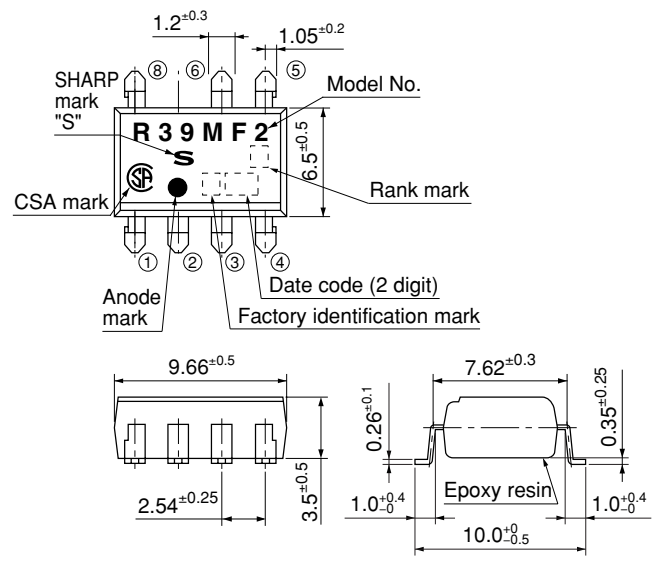

Product mass : approx. 0.54g

■ Outline Dimensions

(Unit : mm)

5. Through-Hole VDE option [ex. PR39MF21YSZF]

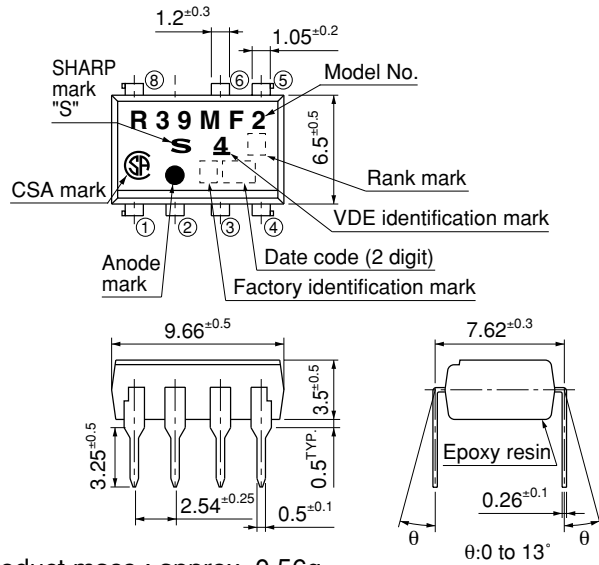

6. SMT Gullwing Lead-Form VDE option [ex. PR39MF21YIPF]

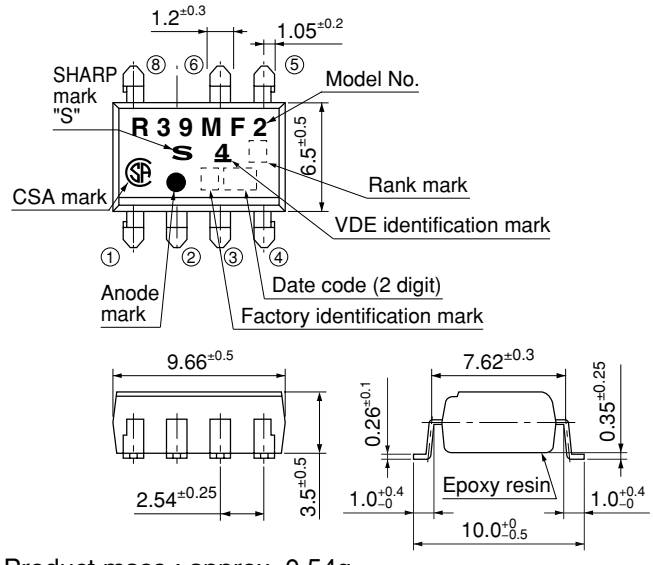

## Date code (2 digit)

1st digit				2nd digit	
Year of production				Month of production	
A.D.	Mark	A.D.	Mark	Month	Mark
1990	A	2002	P	January	1
1991	B	2003	R	February	2
1992	C	2004	S	March	3
1993	D	2005	T	April	4
1994	E	2006	U	May	5
1995	F	2007	V	June	6
1996	H	2008	W	July	7
1997	J	2009	X	August	8
1998	K	2010	A	September	9
1999	L	2011	B	October	O
2000	M	2012	C	November	N
2001	N	∴	∴	December	D

repeats in a 20 year cycle

## Factory identification mark

Factory identification Mark	Country of origin
no mark	Japan
	

\* This factory marking is for identification purpose only.  
Please contact the local SHARP sales representative to see the actual status of the production.

## Rank mark

Please refer to the Model Line-up table.

### Absolute Maximum Ratings

(T<sub>a</sub>=25°C)

Parameter		Symbol	Rating	Unit	
Input	Forward current	I <sub>F</sub>	50 <sup>*3</sup>	mA	
	Reverse voltage	V <sub>R</sub>	6	V	
Output	RMS ON-state current	I <sub>T(rms)</sub>	0.9 <sup>*3</sup>	A	
	Peak one cycle surge current	I <sub>surge</sub>	9 <sup>*4</sup>	A	
	Repetitive peak OFF-state voltage	PR29MF21NSZ	V <sub>DRM</sub>	400	V
		PR39MF2xNSZ		600	
*1 Isolation voltage		V <sub>iso(rms)</sub>	4.0	kV	
Operating temperature		T <sub>opr</sub>	-30 to +85	°C	
Storage temperature		T <sub>stg</sub>	-40 to +125	°C	
*2 Soldering temperature		T <sub>sol</sub>	270 <sup>*5</sup>	°C	

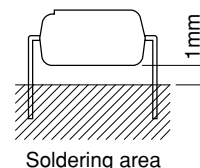

\*1 40 to 60%RH, AC for 1minute, f=60Hz

\*2 For 10s

\*3 Refer to Fig.1, Fig.2

\*4 f=50Hz sine wave

\*5 Lead solder plating models: 260°C

### Electro-optical Characteristics

(T<sub>a</sub>=25°C)

Parameter		Symbol	Conditions	MIN.	TYP.	MAX.	Unit	
Input	Forward voltage	V <sub>F</sub>	I <sub>F</sub> =20mA	-	1.2	1.4	V	
	Reverse current	I <sub>R</sub>	V <sub>R</sub> =3V	-	-	10	μA	
Output	Repetitive peak OFF-state current	I <sub>DRM</sub>	V <sub>D</sub> =V <sub>DRM</sub>	-	-	100	μA	
	ON-state voltage	V <sub>T</sub>	I <sub>T</sub> =0.9A	-	-	3.0	V	
	Holding current	I <sub>H</sub>	V <sub>D</sub> =6V	-	-	25	mA	
	Critical rate of rise of OFF-state voltage	dV/dt	V <sub>D</sub> =1/√2 · V <sub>DRM</sub>	100	-	-	V/μs	
	Zero cross voltage	Rank 1	V <sub>OX</sub>	I <sub>F</sub> =15mA, Resistance load	-	-	35	V
		Rank 2		I <sub>F</sub> =10mA, Resistance load	-	-	-	
Transfer characteristics	Minimum trigger current	Rank 1	V <sub>D</sub> =6V, R <sub>L</sub> =100Ω	-	-	10	mA	
		Rank 2		-	-	5		
	Isolation resistance	R <sub>ISO</sub>	DC500V, 40 to 60%RH	5×10 <sup>10</sup>	10 <sup>11</sup>	-	Ω	
	Turn-on time	Rank 1	t <sub>on</sub>	I <sub>F</sub> =20mA, V <sub>D</sub> =6V, R <sub>L</sub> =100Ω	-	-	50	μs
Rank 2		I <sub>F</sub> =10mA, V <sub>D</sub> =6V, R <sub>L</sub> =100Ω		-	-	-		

## ■ Model Line-up

Lead Form	Through-Hole		SMT Gullwing		V <sub>DRM</sub> [V]	Rank mark	I <sub>FT</sub> [mA] (V <sub>D</sub> =6V, R <sub>L</sub> =100Ω)
Shipping Package	Sleeve		Taping				
	50pcs/sleeve		1 000pcs/reel				
DIN EN60747-5-2	—————	Approved	—————	Approved			
Model No.	PR39MF21NSZF	PR39MF21YSZF	PR39MF21N1PF	PR39MF21Y1PF	600	1	MAX. 10
	PR39MF22NSZF	PR39MF22YSZF	PR39MF22N1PF	PR39MF22Y1PF		2	MAX. 5
	PR29MF21NSZF	—————	PR29MF21N1PF	—————	400	1	MAX. 10

Please contact a local SHARP sales representative to see the actual status of the production.

**Fig.1 Forward Current vs. Ambient Temperature**

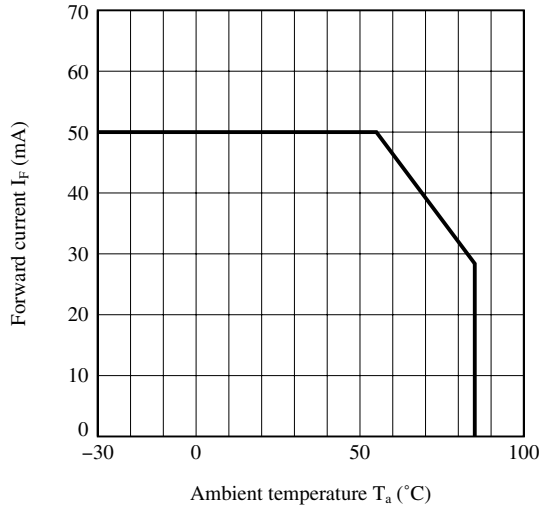

**Fig.2 RMS ON-state Current vs. Ambient Temperature**

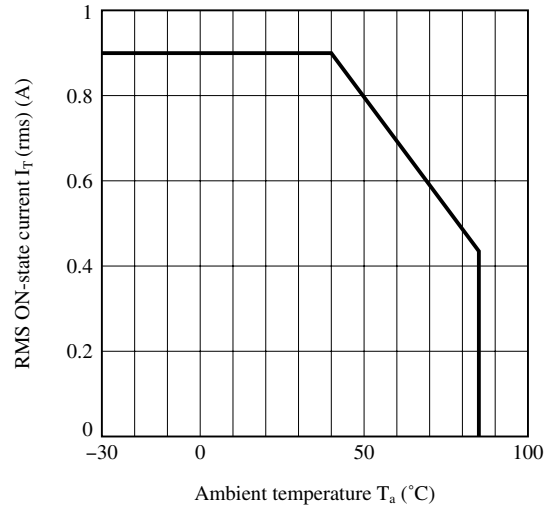

**Fig.3-a Forward Current vs. Forward Voltage (Rank 1)**

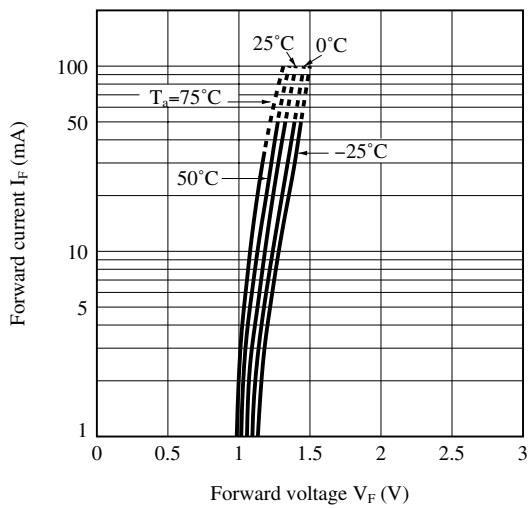

**Fig.3-b Forward Current vs. Forward Voltage (Rank 2)**

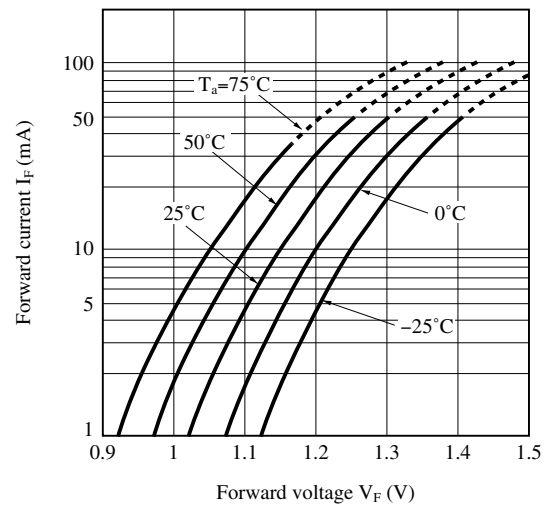

**Fig.4-a Minimum Trigger Current vs. Ambient Temperature (Rank 1)**

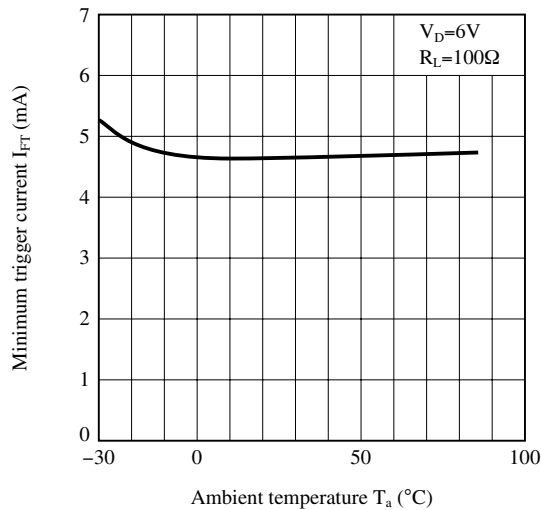

**Fig.4-b Minimum Trigger Current vs. Ambient Temperature (Rank 2)**

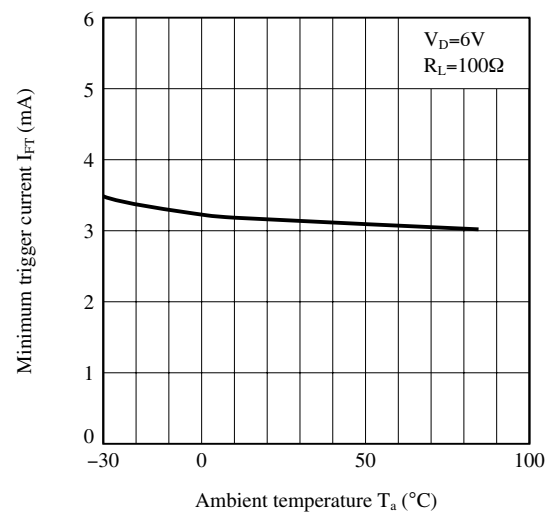

**Fig.5 ON-state Voltage vs. Ambient Temperature**

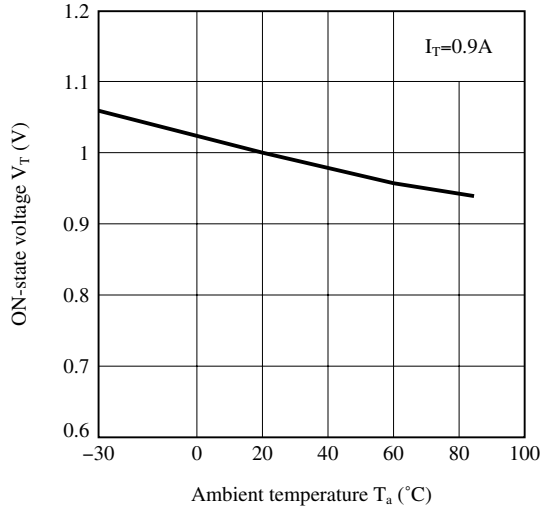

**Fig.6 Relative Holding Current vs. Ambient Temperature**

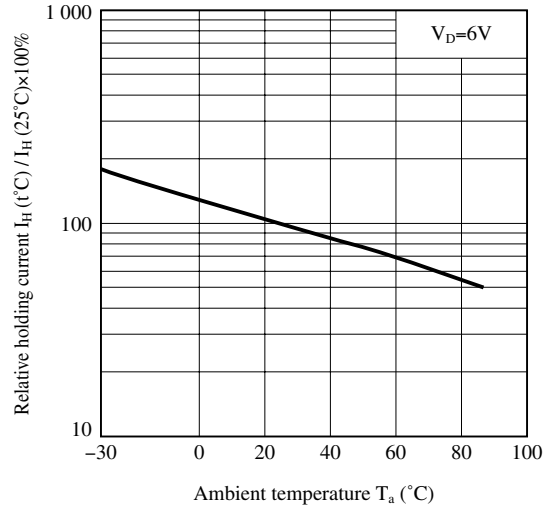

**Fig.7 Zero-cross Voltage vs. Ambient Temperature**

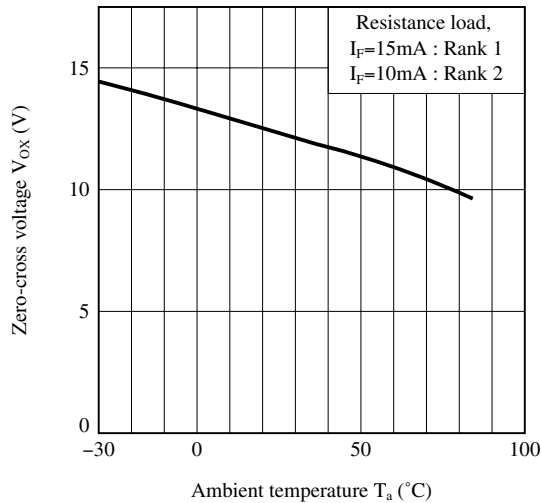

**Fig.8 ON-state Current vs. ON-state Voltage**

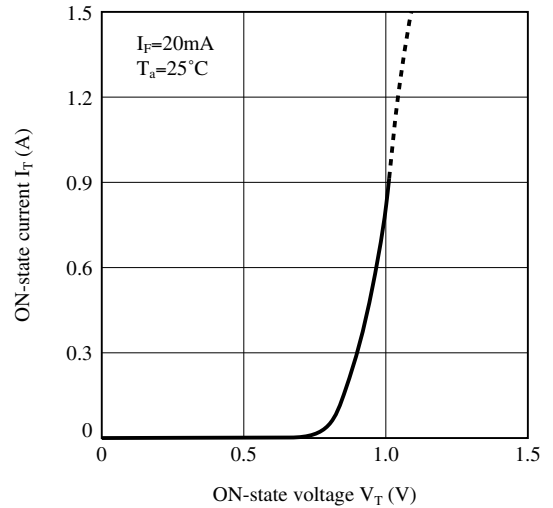

**Fig.9-a Turn-on Time vs. Forward Current (Rank 1)**

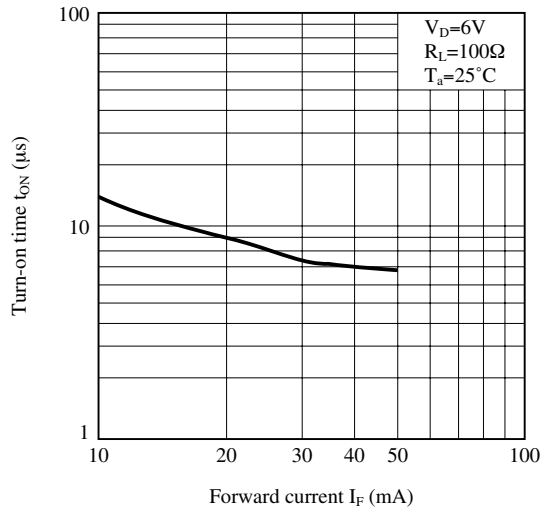

**Fig.9-b Turn-on Time vs. Forward Current (Rank 2)**

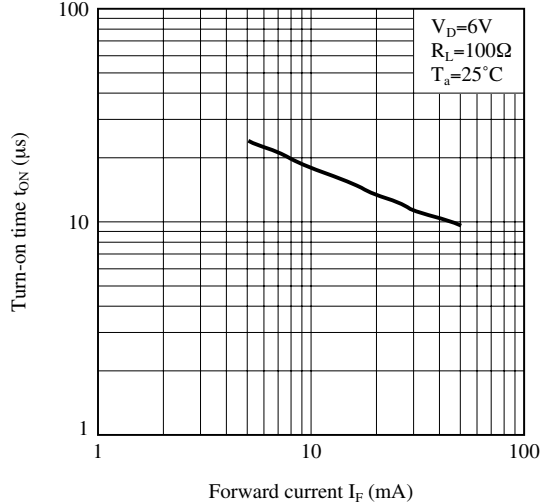

Remarks : Please be aware that all data in the graph are just for reference.



## ■ Design Considerations

### ● Recommended Operating Conditions

Parameter		Symbol	Conditions	MIN.	MAX.	Unit
Input	Input signal current at ON state	Rank 1	-	20	25	mA
		Rank 2				
	Input signal current at OFF state	$I_F(\text{OFF})$	-	0	0.1	mA
Output	Load supply voltage	PR29MF21NSZ	$V_{\text{OUT}}(\text{rms})$	-	120	V
		PR39MF2xNSZ			240	
	Load supply current	$I_{\text{OUT}}(\text{rms})$	Locate snubber circuit between output terminals ( $C_s=0.022\mu\text{F}$ , $R_s=47\Omega$ )	-	$I_T(\text{rms})\times 80\%(^*)$	mA
	Frequency	f	-	50	60	Hz
Operating temperature		$T_{\text{opr}}$	-	-20	80	°C

(\*) See Fig.2 about derating curve ( $I_T(\text{rms})$  vs. ambient temperature).

### ● Design guide

In order for the SSR to turn off, the triggering current ( $I_F$ ) must be 0.1mA or less.

Particular attention needs to be paid when utilizing SSRs that incorporate zero crossing circuitry.

If the phase difference between the voltage and the current at the output pins is large enough, zero crossing type SSRs cannot be used. The result, if zero crossing SSRs are used under this condition, is that the SSR may not turn on and off irregardless of the input current. In this case, only a non zero cross type SSR should be used in combination with the above mentioned snubber circuit selection process.

When the input current ( $I_F$ ) is below 0.1mA, the output Triac will be in the open circuit mode. However, if the voltage across the Triac,  $V_D$ , increases faster than rated  $dV/dt$ , the Triac may turn on. To avoid this situation, please incorporate a snubber circuit. Due to the many different types of load that can be driven, we can merely recommend some circuit values to start with :  $C_s=0.022\mu\text{F}$  and  $R_s=47\Omega$ . The operation of the SSR and snubber circuit should be tested and if unintentional switching occurs, please adjust the snubber circuit component values accordingly.

When making the transition from On to Off state, a snubber circuit should be used ensure that sudden drops in current are not accompanied by large instantaneous changes in voltage across the Triac.

This fast change in voltage is brought about by the phase difference between current and voltage.

Primarily, this is experienced in driving loads which are inductive such as motors and solenods.

Following the procedure outlined above should provide sufficient results.

For over voltage protection, a Varistor may be used.

Any snubber or Varistor used for the above mentioned scenarios should be located as close to the main output triac as possible.

All pins shall be used by soldering on the board. (Socket and others shall not be used.)

### ● Degradation

In general, the emission of the IRED used in SSR will degrade over time.

In the case where long term operation and / or constant extreme temperature fluctuations will be applied to the devices, please allow for a worst case scenario of 50% degradation over 5years.

Therefore in order to maintain proper operation, a design implementing these SSRs should provide at least twice the minimum required triggering current from initial operation.

● **Recommended Foot Print (reference)**

SMT Gullwing Lead-form

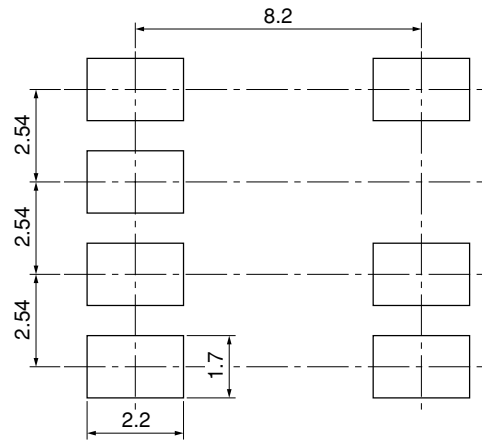

(Unit : mm)

● **Standard Circuit**

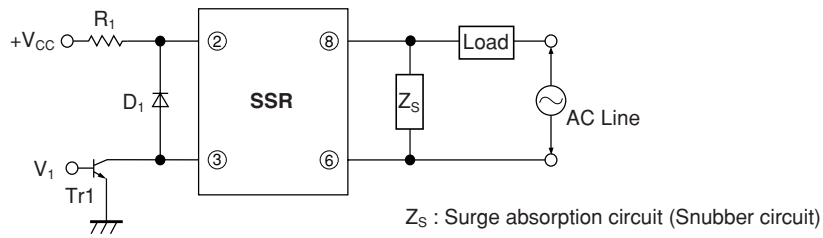

☆ For additional design assistance, please review our corresponding Optoelectronic Application Notes.

## ■ Manufacturing Guidelines

### ● Soldering Method

#### Reflow Soldering:

Reflow soldering should follow the temperature profile shown below.  
Soldering should not exceed the curve of temperature profile and time.  
Please don't solder more than twice.

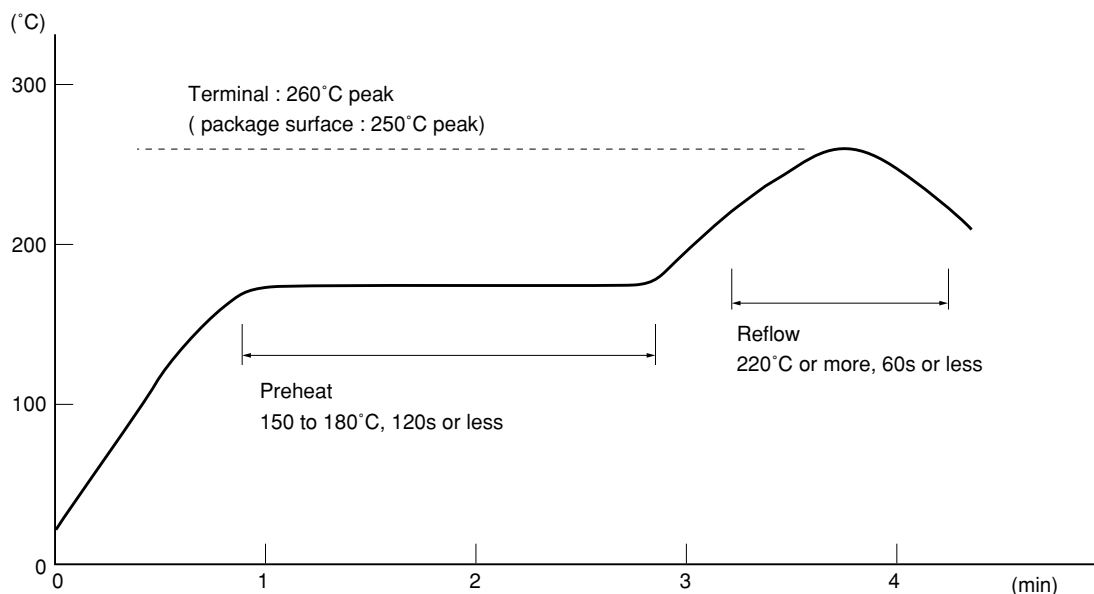

#### Flow Soldering :

Flow soldering should be completed below 270°C and within 10s.  
Preheating is within the bounds of 100 to 150°C and 30 to 80s.  
Please don't solder more than twice.

#### Hand soldering

Hand soldering should be completed within 3s when the point of solder iron is below 400°C.  
Please don't solder more than twice.

#### Other notices

Please test the soldering method in actual condition and make sure the soldering works fine, since the impact on the junction between the device and PCB varies depending on the tooling and soldering conditions.

**● Cleaning instructions****Solvent cleaning :**

Solvent temperature should be 45°C or below. Immersion time should be 3minutes or less.

**Ultrasonic cleaning :**

The impact on the device varies depending on the size of the cleaning bath, ultrasonic output, cleaning time, size of PCB and mounting method of the device.

Therefore, please make sure the device withstands the ultrasonic cleaning in actual conditions in advance of mass production.

**Recommended solvent materials :**

Ethyl alcohol, Methyl alcohol and Isopropyl alcohol.

In case the other type of solvent materials are intended to be used, please make sure they work fine in actual using conditions since some materials may erode the packaging resin.

**● Presence of ODC**

This product shall not contain the following materials.

And they are not used in the production process for this device.

Regulation substances : CFCs, Halon, Carbon tetrachloride, 1.1.1-Trichloroethane (Methylchloroform)

Specific brominated flame retardants such as the PBBOs and PBBs are not used in this product at all.

■ **Package specification**

● **Sleeve package  
Through-Hole**

Package materials

Sleeve : HIPS (with anti-static material)

Stopper : Styrene-Elastomer

Package method

MAX. 50pcs of products shall be packaged in a sleeve.

Both ends shall be closed by tabbed and tabless stoppers.

The product shall be arranged in the sleeve with its anode mark on the tabless stopper side.

MAX. 20 sleeves in one case.

Sleeve outline dimensions

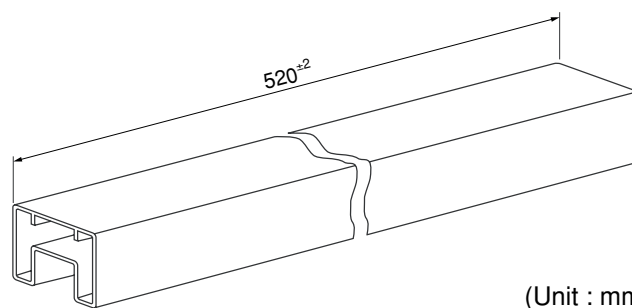
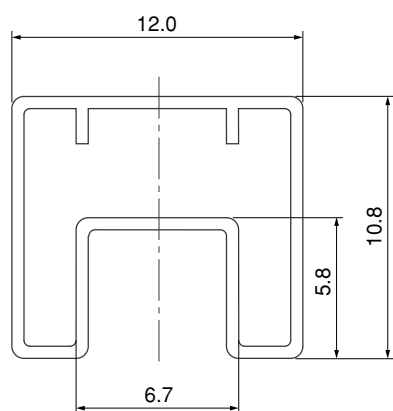

(Unit : mm)

● Tape and Reel package

SMT Gullwing

Package materials

Carrier tape : A-PET (with anti-static material)

Cover tape : PET (three layer system)

Reel : PS

Carrier tape structure and Dimensions

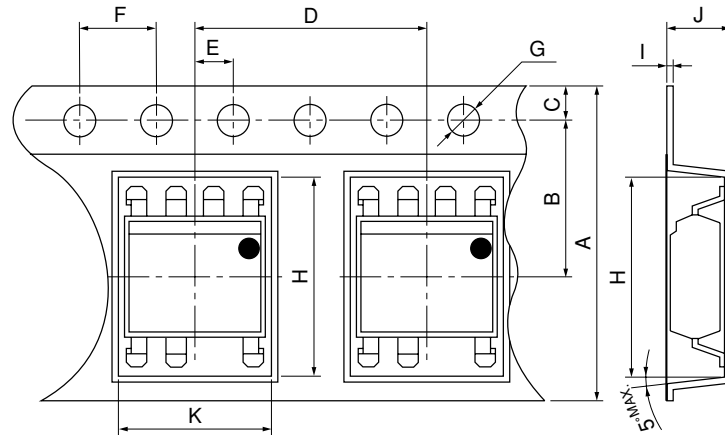

Dimensions List (Unit : mm)

A	B	C	D	E	F	G
16.0±0.3	7.5±0.1	1.75±0.1	12.0±0.1	2.0±0.1	4.0±0.1	φ1.5±0.1
H	I	J	K			
10.4±0.1	0.4±0.05	4.2±0.1	10.2±0.1			

Reel structure and Dimensions

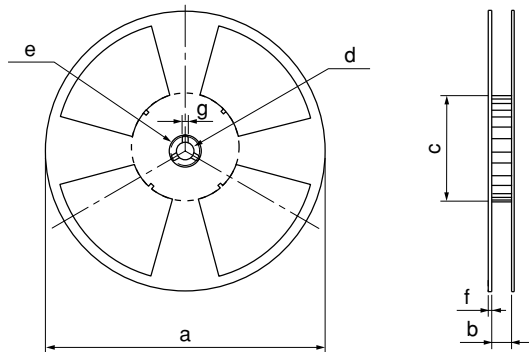

Dimensions List (Unit : mm)

a	b	c	d
330	17.5±1.5	100±1.0	13±0.5
e	f	g	
23±1.0	2.0±0.5	2.0±0.5	

Direction of product insertion

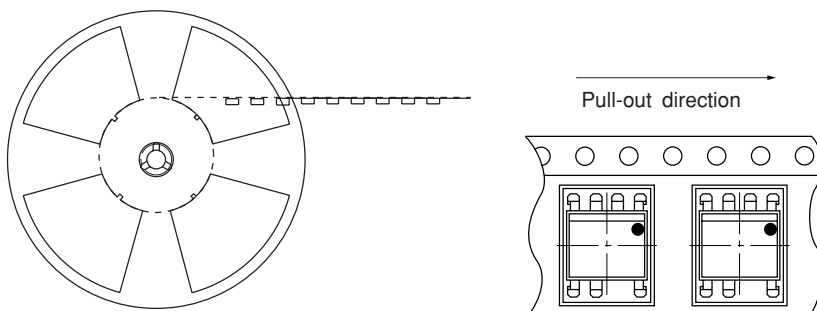

[Packing : 1 000pcs/reel]

## ■ Important Notices

· The circuit application examples in this publication are provided to explain representative applications of SHARP devices and are not intended to guarantee any circuit design or license any intellectual property rights. SHARP takes no responsibility for any problems related to any intellectual property right of a third party resulting from the use of SHARP's devices.

· Contact SHARP in order to obtain the latest device specification sheets before using any SHARP device. SHARP reserves the right to make changes in the specifications, characteristics, data, materials, structure, and other contents described herein at any time without notice in order to improve design or reliability. Manufacturing locations are also subject to change without notice.

· Observe the following points when using any devices in this publication. SHARP takes no responsibility for damage caused by improper use of the devices which does not meet the conditions and absolute maximum ratings to be used specified in the relevant specification sheet nor meet the following conditions:

(i) The devices in this publication are designed for use in general electronic equipment designs such as:

- Personal computers
- Office automation equipment
- Telecommunication equipment [terminal]
- Test and measurement equipment
- Industrial control
- Audio visual equipment
- Consumer electronics

(ii) Measures such as fail-safe function and redundant design should be taken to ensure reliability and safety when SHARP devices are used for or in connection

with equipment that requires higher reliability such as:

- Transportation control and safety equipment (i.e., aircraft, trains, automobiles, etc.)
- Traffic signals
- Gas leakage sensor breakers
- Alarm equipment
- Various safety devices, etc.

(iii) SHARP devices shall not be used for or in connection with equipment that requires an extremely high level of reliability and safety such as:

- Space applications
- Telecommunication equipment [trunk lines]
- Nuclear power control equipment
- Medical and other life support equipment (e.g., scuba).

· If the SHARP devices listed in this publication fall within the scope of strategic products described in the Foreign Exchange and Foreign Trade Law of Japan, it is necessary to obtain approval to export such SHARP devices.

· This publication is the proprietary product of SHARP and is copyrighted, with all rights reserved. Under the copyright laws, no part of this publication may be reproduced or transmitted in any form or by any means, electronic or mechanical, for any purpose, in whole or in part, without the express written permission of SHARP. Express written permission is also required before any use of this publication may be made by a third party.

· Contact and consult with a SHARP representative if there are any questions about the contents of this publication.